

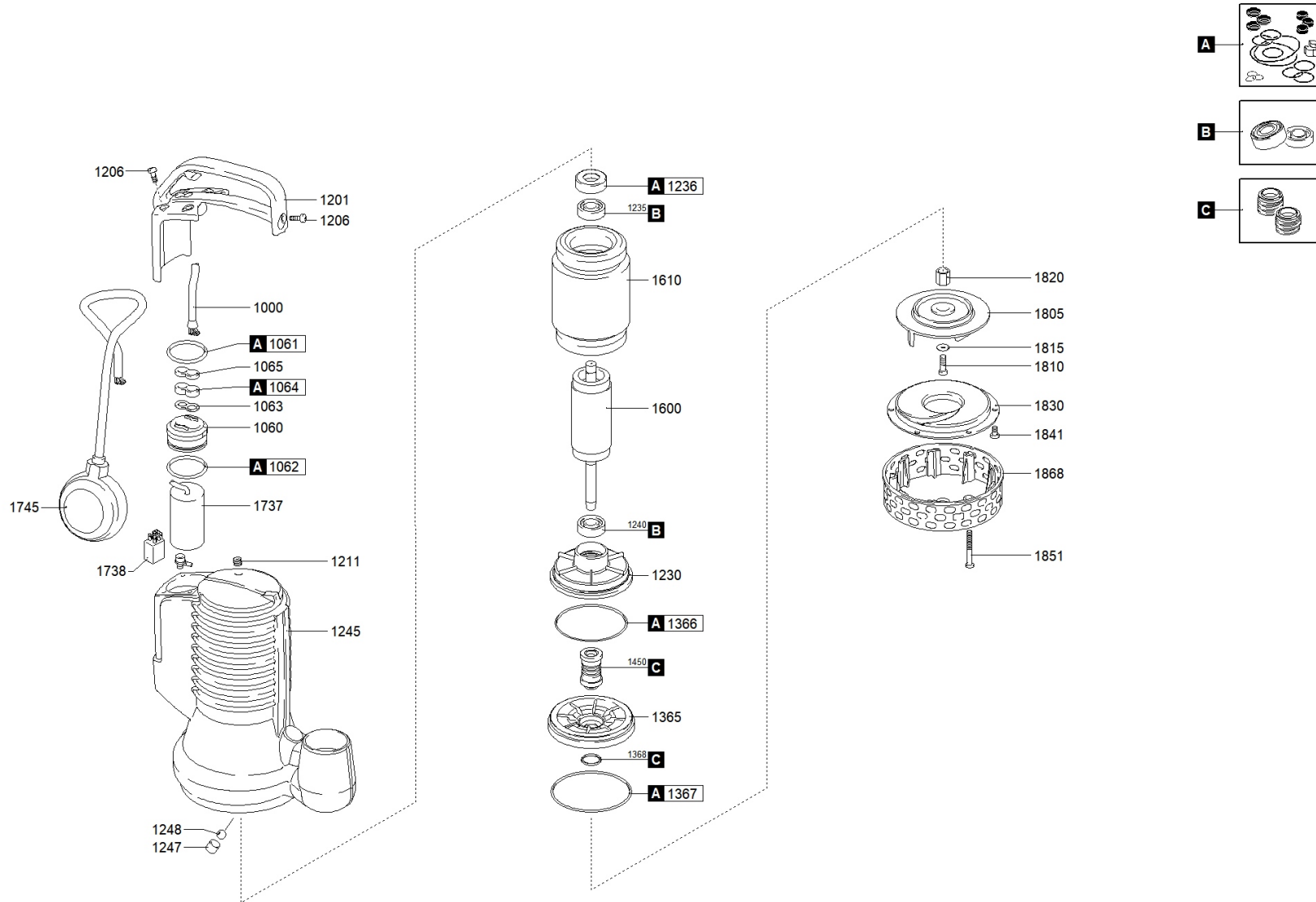

better together

1094.006 - DRBLUEP 50/2/G32V A1BM5 NGTGB51U23NR0NN





better together



1094.006 - DRBLUEP 50/2/G32V A1BM5 NGTGB51U23NR0NN

		Code		New Code		Description	Q.ty
A		601008001		9050.001		GASKETS KIT	1
C		602008021		9050.103		MECHANICAL SEALS KIT	1
B		604008301		9050.166		BEARINGS KIT	1
1000		250102304010200000		2501NN00004		CAVO POTENZA	1
1060		239768026156		2397PL00001		HOLDER [CABLE GLAND]	1
1061		271770412835300000		2717GM00061		UPPER GASKET - HOLDER [CABLE GLAND]	1
1062		271770040952620000		2717GM00058		LOWER GASKET - HOLDER [CABLE GLAND]	1
1063		235467024279		2354PL00001		CABLE STOP	1
1064		235678024236		2356GM00032		RUBBER GASKET	1
1065		235467024241		2354PL00006		CABLE GLAND	1
1201		235360424137		2353PL00001		CABLE GLAND HANDLE	1
1206		270830510149200000		2708XX00087		SCREW [CABLE GLAND HANDLE >> COVER]	5
1211		270139510104000000		2701XX00003		CAP [TIGHTNESS TEST]	1
1230		230556223465		2305AL00001		LOWER BEARING HOLDER	1
1235		2729062010200000		2729NN00007		UPPER BEARING	1
1236		238579023531		2385GM00001		RUBBER PROTECTION [UPPER BEARING]	1
1240		2729062010200000		2729NN00007		LOWER BEARING	1
1245		231016224290		2310GG00027		MOTOR CASE	1
1247		2307605724327		2307PL00002		BUSH [BREATHER]	1
1248		273077224326		2730GM00001		BALL [BREATHER]	1
1365		2391000015023462		2391NN00001		MECHANICAL SEAL FLANGE	1
1366		271770088035000000		2717GM00091		GASKET [LOWER BEARING HOLDER >> MECHANICAL SEAL FLANGE]	1
1367		271770079018000000		2717GM00086		GASKET [MECHANICAL SEAL FLANGE >> BASE]	1
1368		237970100160600000		2379GM00017		V-RING [MECHANICAL SEAL FLANGE]	1
1450		230005040120000000		2300NN00029		MECHANICAL SEAL	1
1600		230233611223480		2302NN00131		SHAFT WITH ROTOR	1
1610		231101121006000000		2311NN00059		WOUND STATOR	1
1737		25170060000000		2517NN00001		CAPACITOR	1
1745		2545004053000000		2545NN00007		FLOAT SWITCH	1
1805		21411000630424298		2141GG00177		IMPELLER	1
1810		270830510209200000		2708XX00090		LOCKING IMPELLER	1
1815		270530202073000000		2705XX00024		LOCKING WASHER [IMPELLER]	1
1830		2162311323458		2162XX00005		SUCTION FLANGE	1
1841		270830510109200000		2708XX00084		SCREW [SUCTION FLANGE >> MOTOR CASE]	3
1851		270830510459200000		2708XX00092		SCREW [STRAINER >> SUCTION FLANGE]	3
1868		216533624230		2165XX00004		CLOSED STRAINER	1

